



## Specification

### Material

All ALUMINIUM

### Curtain

100mm open grille constructed of extruded aluminium bars and links.

### Curtain Types

PUNCHED EFFECT where permanent vision is required link spacing 150mm standard: 75mm and brick bond effect are optional.

### Bottom Rail

A 93mm heavy duty bottom slat with reinforcing angle is supplied as standard

### Guide Rail

THREE types available - 60mm x 27mm; 75mm x 27mm; 90mm x 34mm dependent on box size.

### Box

Shutter Boxes from 205mm<sup>2</sup> - rolled formed from stove enamelled aluminium sheet with 45 degree chamfer on front lower corner.

### Maximum Size

Maximum width: 5.0 metres  
Maximum height: 4.0 metres

### Suggested Security Level

**MEDIUM**

### Application

- Internal
- Doors
- Windows
- Bar & Servery





Decor-Grille Security

# Roller Shutter

aluminium

## Methods of Fixing

### Face Fixing

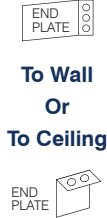
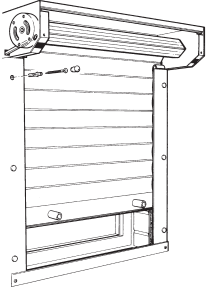

### Reveal Fixing

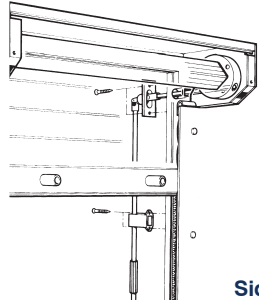

## Product Size Parameters

Weight of curtain 7kg/Sq Metre	Manual		Electric		Electric Mor*	
	Min	Max	Min	Max	Min	Max
Width	755	4600	660	5000	710	5000
Height	500	2800	500	4000	500	4000

\*including manual override in case of power failures.

## Colours

Shutter curtain	Silver Anodised	
Shutterbox, Guide Rails & Bottom Slat	White RAL 9010	Brown RAL 8014
Other RAL colours available for a surcharge		

## Section Through Box Guide

### Key Point 1

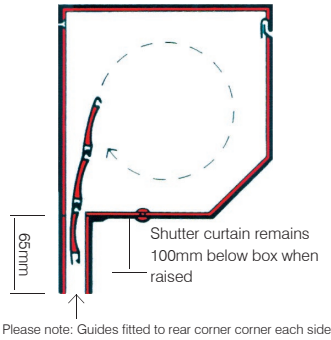

## Shutter Assembly

### Key Point 2

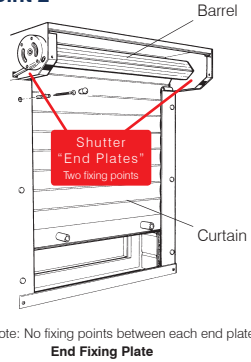

## Shutter Curtain

### Key Point 3

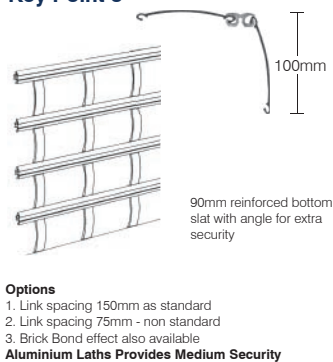

## Locking System/Box Lid

### Key Point 4

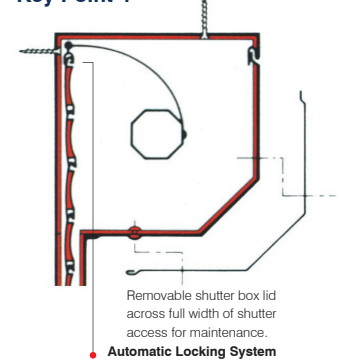

## Types of Operation

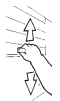

**Manual Spring Loaded**  
Only for operating on same side as shutter.

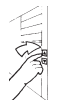

**Electric Motor & Switch**  
These are required on larger shutters optional on smaller shutters. Various control systems available. See separate sheet.

## Guide Options

### Standard Guide Rail

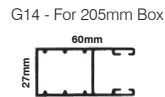

### Standard Guide Rail

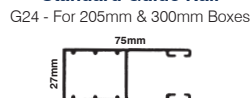

### Optional Guide Rail



## Maximum Widths & Height for various shutter box sizes

Max Width (mm) Including Guide Rails	Max Shutter Height (mm) Including Box	Electric Box Box Size (mm)
5000	500-1600	205
5000	1601-2600	250
4600	2601-2800	250
4200	2801-3000	300
4000	3001-3200	300
3800	3201-3400	300
3600	3401-3600	300
3400	3601-3800	300
3200	3801-4000	300

## Guide Fixings

### Face Fix

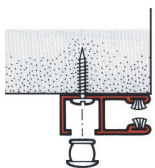

### Reveal Fix

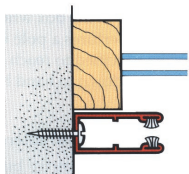

## Optional Extras

### Electric

- Manual override - in case of power failure.
- Manual override lock - for extra security

### Manual

- Guide rail bullet locks for extra security. To be used in conjunction with 70mm guide or above.
- Cill angle 30 x 20 or 70 x 20.
- Reinforced bottom slat angle/handle for extra security.
- Removable guide rails for bar/servey with shoot bolts together with a recessed 40mm socket & dust cap.

Max Width (mm) Including Guide Rails	Max Shutter Height (mm) Including Box	Manual Box Size (mm)
4600	500-1600	205
4600	1601-1800	250
4400	1801-2400	250
4200	2401-2800	250

Decor Grille Security, 147 Easterly Road, Leeds, LS8 2RY

Tel: 0113 248 4747

Fax: 0113 248 7858

Email: info@dgsecurity.co.uk

www.dgsecurity.co.uk